

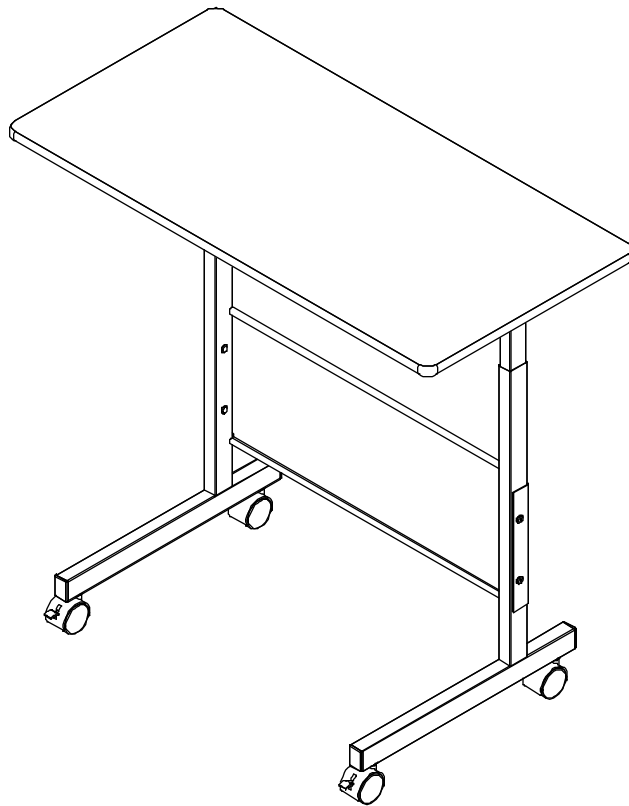

#89791 LT-TABLE











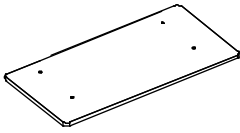













Adjustable Height Laptop Table



Assembly Instructions

#89791 LT-Table

Laptop Table

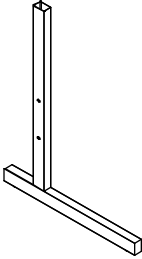
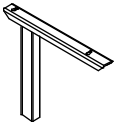
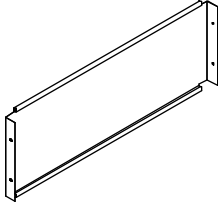
Part	Drawing	Description	Qty	Part	Drawing	Description	Qty																																
P1		Top Platform	1 EA	<div style="border: 2px solid black; border-radius: 15px; padding: 10px;"> <p style="text-align: center;">Hardware List</p> <table border="0"> <tr> <td>A</td> <td></td> <td>Short Socket Screw</td> <td>8 EA</td> </tr> <tr> <td>B</td> <td></td> <td>Interior Threaded Post</td> <td>4 EA</td> </tr> <tr> <td>C</td> <td></td> <td>Philips Pan Head Screw</td> <td>2 EA</td> </tr> <tr> <td>D</td> <td></td> <td>2" Locking Caster</td> <td>2 EA</td> </tr> <tr> <td>E</td> <td></td> <td>2" Caster</td> <td>2 EA</td> </tr> <tr> <td>F</td> <td></td> <td>Allen Wrench</td> <td>1 EA</td> </tr> <tr> <td>G</td> <td></td> <td>Caster Wrench</td> <td>1 EA</td> </tr> <tr> <td>H</td> <td></td> <td>Leveling Glide</td> <td>4 EA</td> </tr> </table> <p style="text-align: center;"><i>We recommend that you assemble this unit on a table.</i></p> </div>				A		Short Socket Screw	8 EA	B		Interior Threaded Post	4 EA	C		Philips Pan Head Screw	2 EA	D		2" Locking Caster	2 EA	E		2" Caster	2 EA	F		Allen Wrench	1 EA	G		Caster Wrench	1 EA	H		Leveling Glide	4 EA
A		Short Socket Screw	8 EA																																				
B		Interior Threaded Post	4 EA																																				
C		Philips Pan Head Screw	2 EA																																				
D		2" Locking Caster	2 EA																																				
E		2" Caster	2 EA																																				
F		Allen Wrench	1 EA																																				
G		Caster Wrench	1 EA																																				
H		Leveling Glide	4 EA																																				
P2		Lower Leg Receiver	2 EA																																				
P3		Upper Leg Insert	2 EA																																				
P4		Metal Stability Panel	1 EA																																				

Missing Parts or UPS Damaged Parts

For Your Convenience you can
EMAIL us at
furniture@baltinc.com
24HOURS 7 DAYS A WEEK

Should you require assistance during assembly,

*please call our Customer Service Department
Monday - Friday 8 a.m. - 5 p.m.
Central Standard Time 1-800-749-2258*

Do not use unless all screws are tight. At least every six months, check all screws to be sure they are tight. If parts are missing, broken, damaged, or worn, stop use of the product until repairs are made by your dealer using factory authorized parts.

#89791 LT-Table Assembly Diagram



READ THROUGH INSTRUCTIONS FROM BEGINNING TO END BEFORE STARTING TO ASSEMBLE UNIT.

- 1.) Identify and Separate all the Parts and Hardware.
- 2.) Place the Monitor Platform (P1) with the insert nuts facing up. Attach 2 each Upper Leg Inserts (P3) using 4 each (A) screws. **(Finger tighten only)**

Illustration # 1

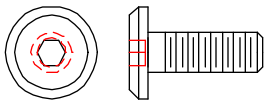
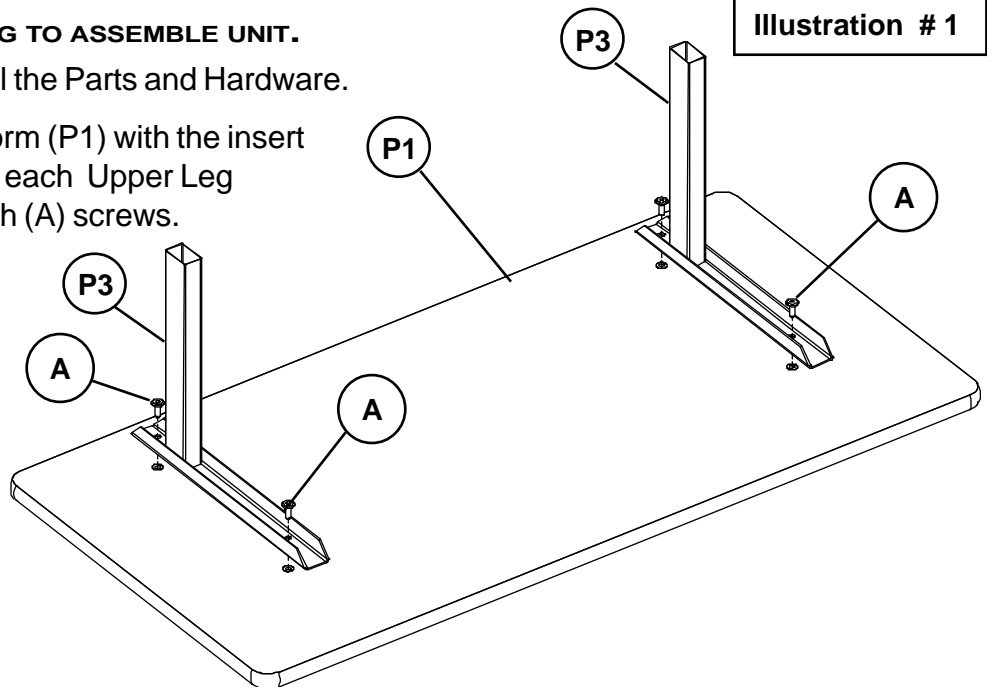

(A) Screw M6 X 9/16"
For Scale only

Illustration #2

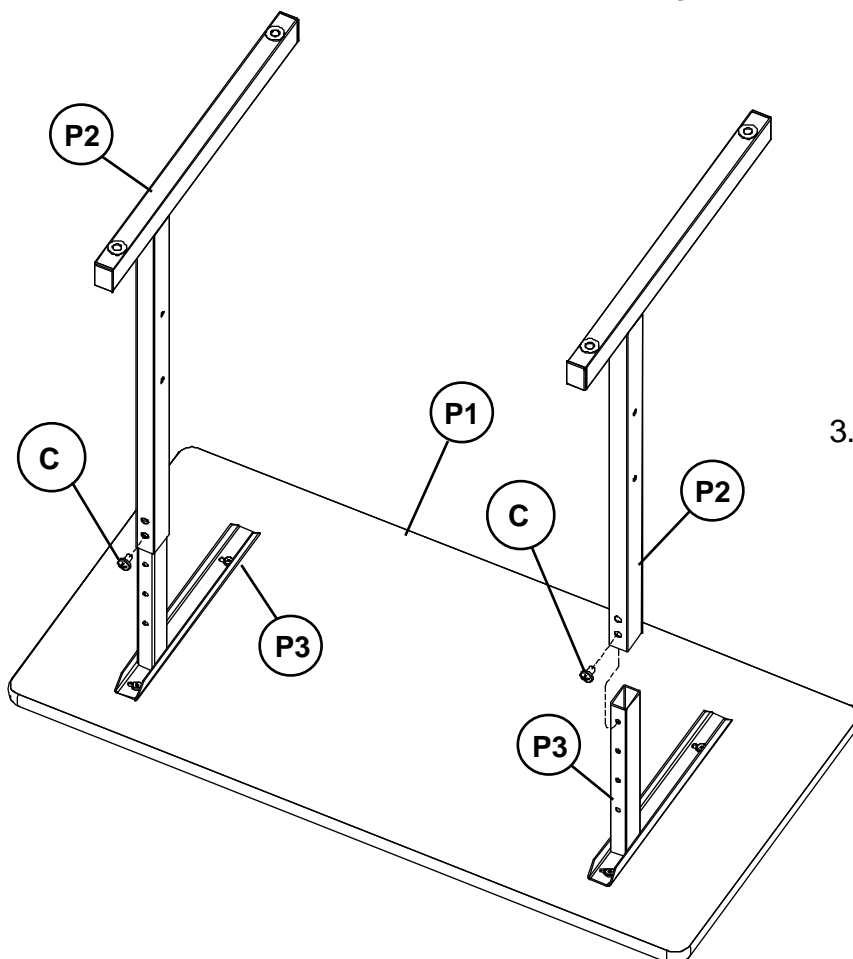

- 3.) Slide 2 Leg Receivers (P2) over 2 Upper Leg Inserts (P3) as shown in illustration #2. Secure at desired height using 2 each Screws (C). **(Finger tighten only)**

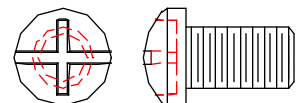

(C) Screw M8 X 9/16"
Phil Pan Head
For Scale only

4.) Attach Metal Stability Panel (P-4) to the 2 each Lower Leg Receivers (P-2) using 4 each Socket Screws (A) and 4 each Interior Threaded Posts(B).

Attach 2 each Locking Casters (D) to the front of the 2 each Lower Leg Receivers (P2) and 2 each Casters (E) to the back of the 2 each Lower Leg Receivers (P2) as shown in illustration #3. Tighten Casters using Caster Wrench (G). Use 4 each Leveling Glides (H) in place of Casters for stationary use.

(Tighten all the screws at this time using Allen Wrench (F)).

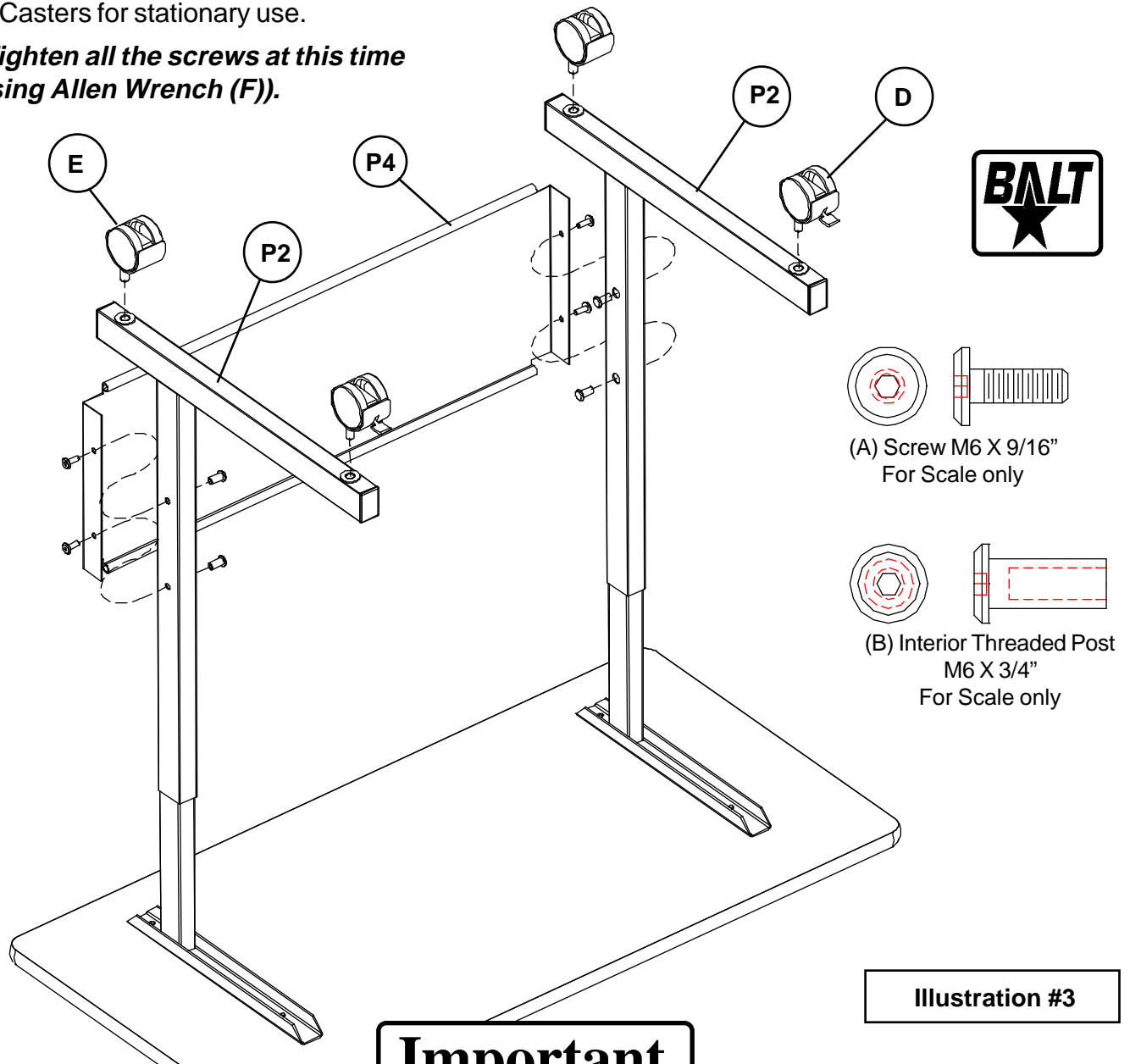

Important

The Balt product you have purchased is guaranteed against material and workmanship defects. This guarantee extends 1 year from date of purchase. Should this product fail to function satisfactorily under normal use due to defect or imperfection, the defective part or product will be replaced. Damage caused by common carriers during shipment is not included in this guarantee.

This guarantee sets forth all applicable guarantees and remedies. No other warranty, expressed or implied shall apply. Failure to follow instructions found in Important Information Section of Owner Sheet shall void the guarantee. Consequential or incidental damages and or costs are not refundable.

#89791 LT-Table

Adjustable Height Laptop Table



For more information
1-800-749-2258

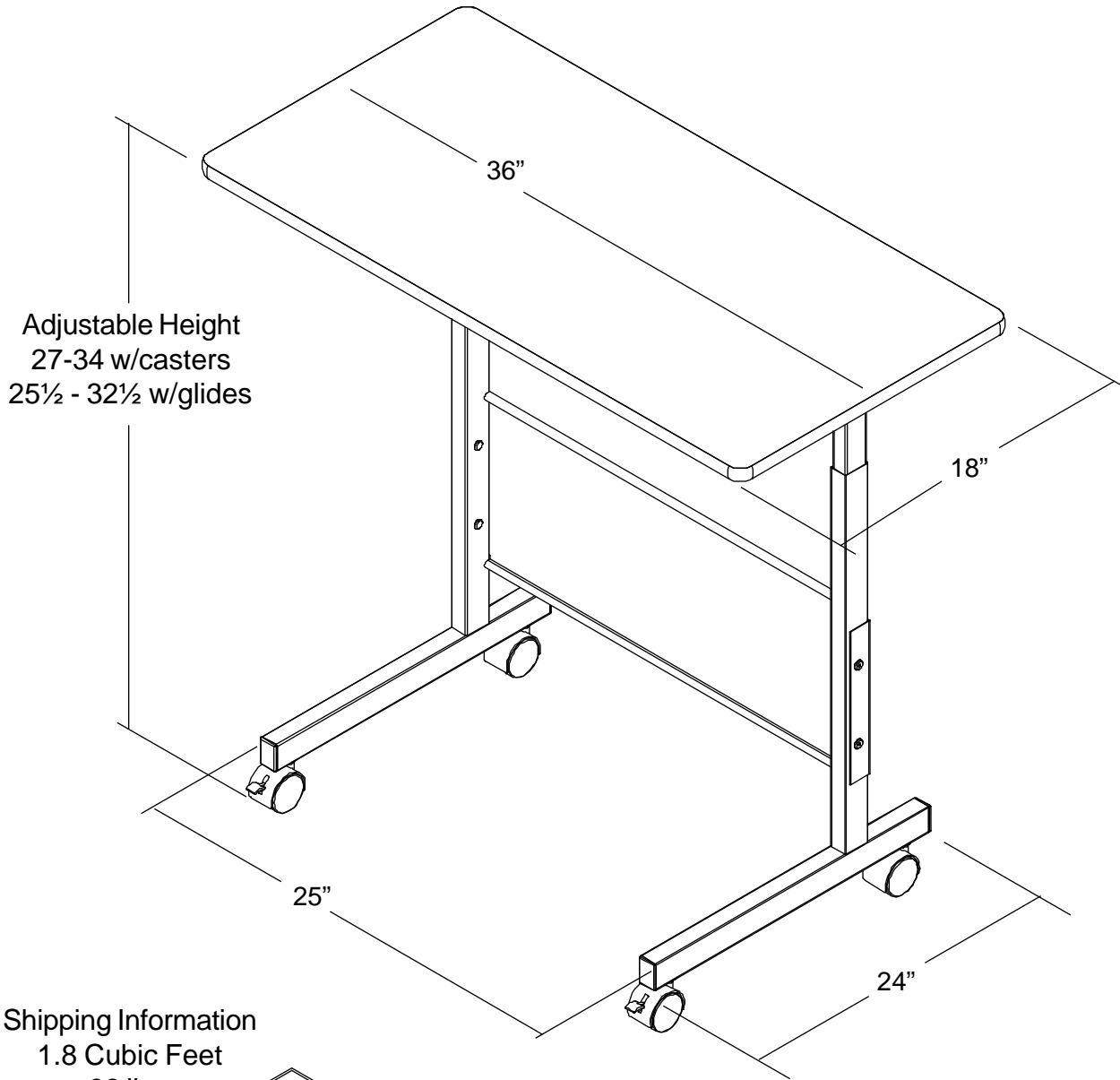

Shipping Information
1.8 Cubic Feet
32 lbs.

